

Pascal Easy ejector rod makes an ejector rod changing dramatically easier.

It is a newly designed ejector rod with strong magnets on the joint surface of the fixed/removable rods, which plugs in/out by one-touch operation.

Number sold
30,000
pieces

5,500kN (550ton) IMM
Changing ejector rod
3min13sec to 30sec



Model designation

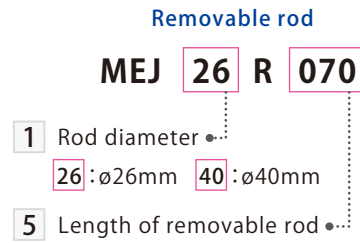
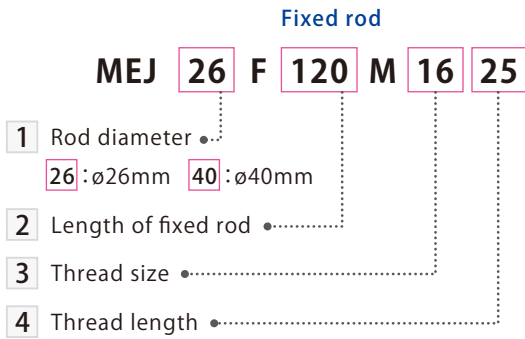

2 3 4 5 Refer to page → 112

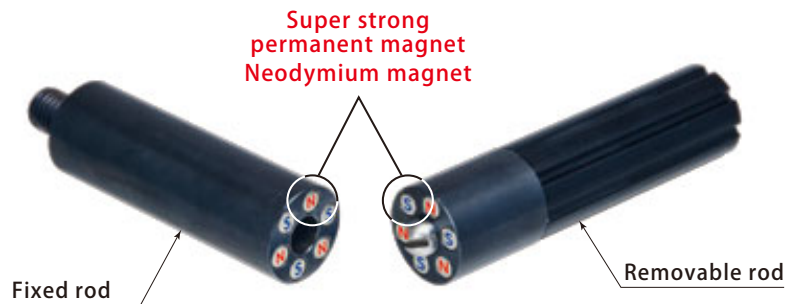
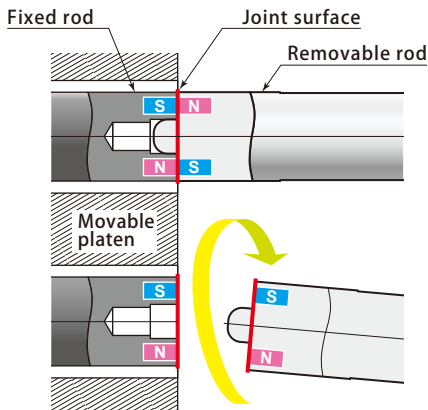

Model		MEJ26	MEJ40
Rod diameter	mm	ø26	ø40
Applied IMM	Clamping force	kN (ton)	13000 (1300) or less
	Loading direction		Vertical loading, Horizontal loading

Conventional ejector rod

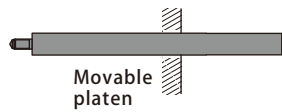

Easy ejector rod

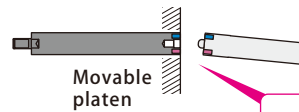

Separated into fixed and removable rod

If using conventional ejector rod,

Heavy ejector rod.

Ex. 350ton class : approx. 3kg
1,000ton class : approx.12kg

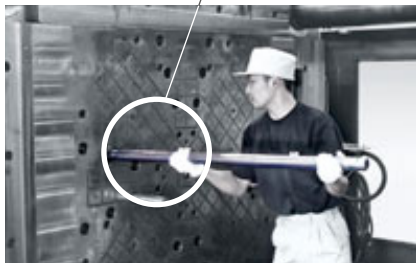

Poor workability and tool dropped easily in machine.

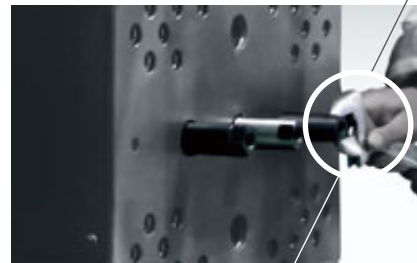

Long thread takes time to screw/unscrew.



Installation in a limited space with bad footing.

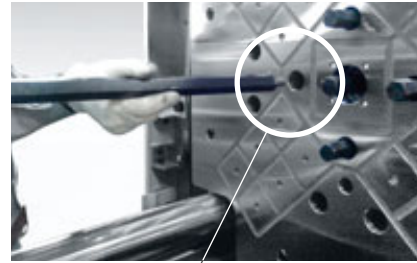

Hard to check the thread and screw hole when screwing.



If using the Easy ejector rod,

Quick installation



Quick de-installation
(Separated into fixed and removable rod)

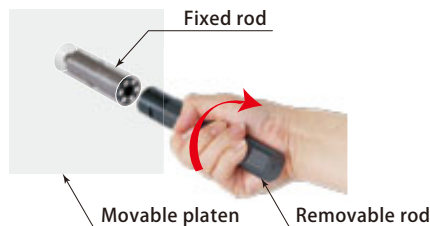

- Only 300g & 1/10-lightweight !!
* 350ton-class
- No tools required
- Avoid dangerous work
- Simply detach removable rods

Easy ejector rod installation example

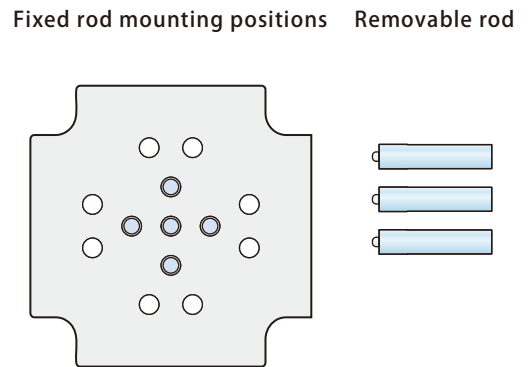
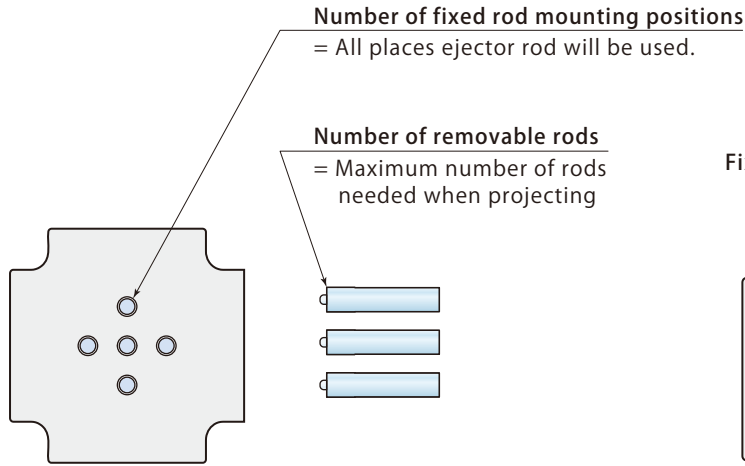

	Rod diameter	Pieces
Fixed rod	ø26	5
Removable rod		3
Jig rod		1

	Rod diameter	Pieces
Fixed rod	ø26	5
Removable rod		3
Jig rod		1

Fixed rod mounting positions Removable rod

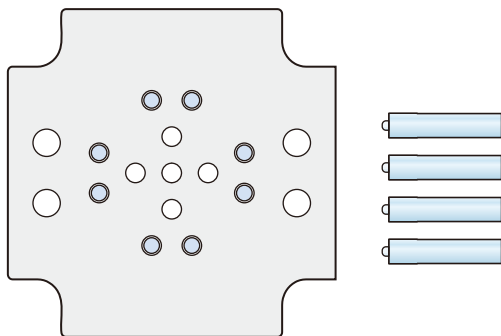

	Rod diameter	Pieces
Fixed rod	ø26	8
Removable rod		4
Jig rod		1

Fixed rod mounting positions Removable rod

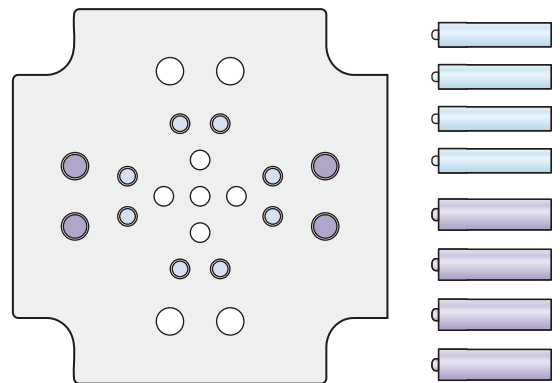

	Rod diameter	Pieces
Fixed rod	ø26	8
Removable rod		4
Jig rod		1
Fixed rod	ø40	4
Removable rod		4
Jig rod		1

Rod dimensions

An existing ejector rod can be used with Easy ejector rod.
Then Easy ejector rod can be used immediately.

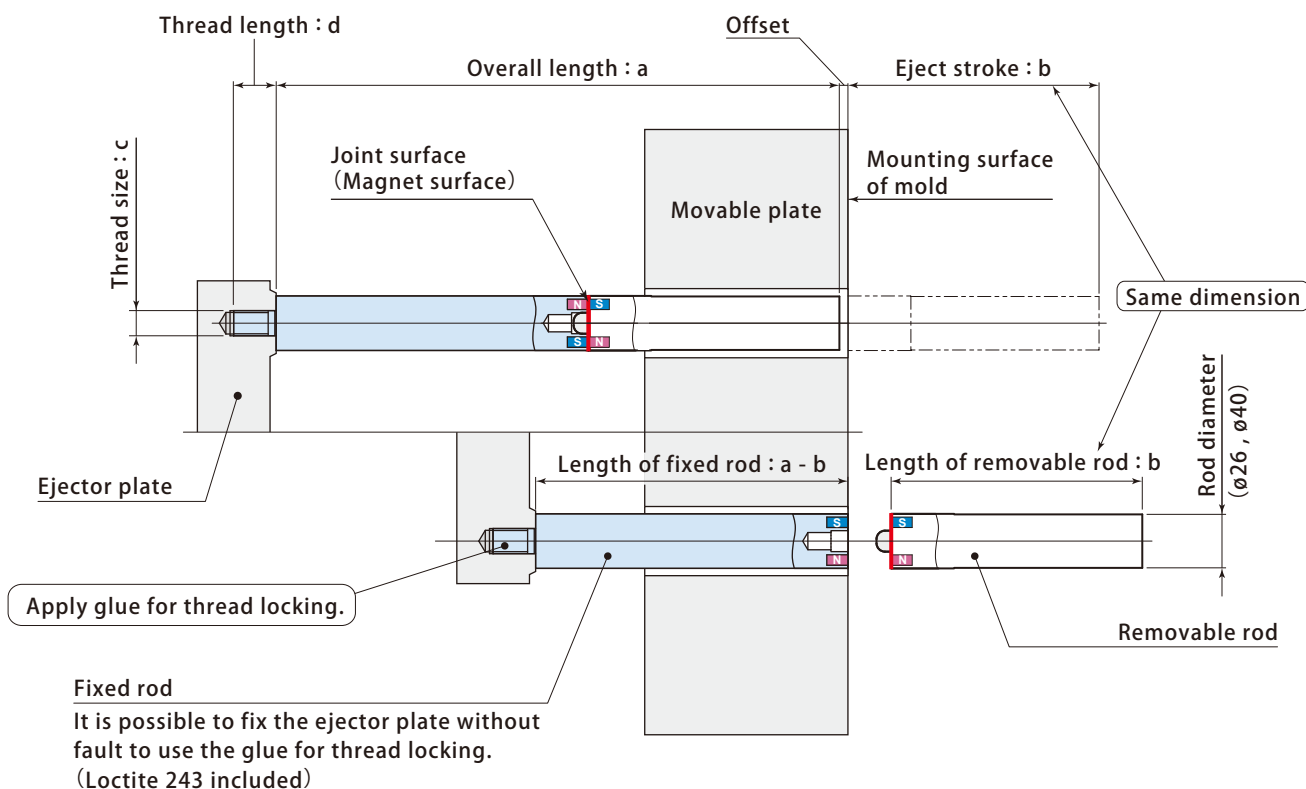

- Upon confirming machine model or above dimensions <a,b,c,d>, Pascal will calculate rod dimensions.
- If special specification is required, please contact Pascal.

Fixed rod

Model	MEJ26F	MEJ40F
Rod diameter mm	ø26	ø40
Length of fixed rod : a - b mm	40 and over	

Removable rod

Model	MEJ26R	MEJ40R
Rod diameter mm	ø26	ø40
Eject stroke : b (Length of removable rod) mm	70 ~ 250	70 ~ 300



Fixed rod Jig rod

Model	MEJ26T	MEJ40T
Rod diameter mm	ø26	ø40

- Mounting jig must be purchased as a set.
Jig rod can be used repeatedly.

1,000kN (100ton) IMM
1min08sec to 6sec



5,500kN (550ton) IMM
5min30sec to 20sec



14,000kN (1,400ton) IMM
3min40sec to 20sec



How to mount fixed rod

- 1 Screw jig rod ⑥ to fixed rod ④ and tighten it up with cap screw.

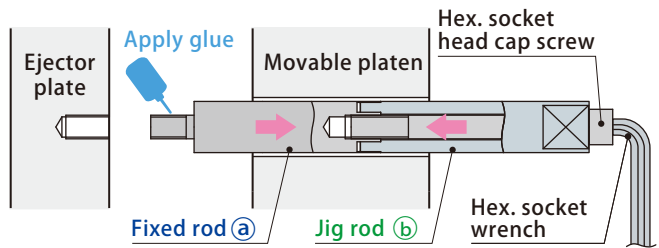

- 2 Screw the rod ④ + ⑥ to the ejector plate then tighten it up by a wrench.

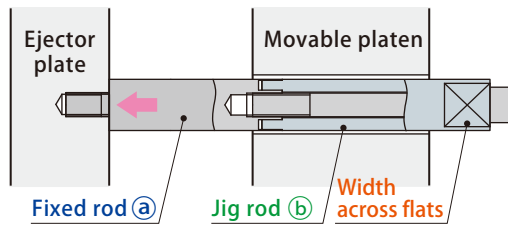

- 3 Remove jig rod ⑥ from fixed rod ④ by loosening the cap screw.

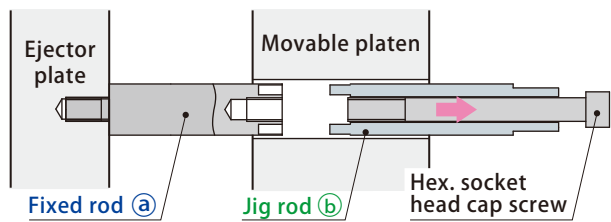

- 4 Screw fixed rod ③ to fixed rod ④ then tighten it by Hex. socket wrench.

